

# Frequency Synchronization Algorithms for OFDM Systems suitable for Communication over Frequency Selective Fading Channels

Ferdinand Classen, Heinrich Meyr

Aachen University of Technology; ISS; Templergraben 55, 52056 Aachen, Germany  
email: classen@ert.rwth-aachen.de

## Abstract

In this paper, the problem of carrier synchronization of OFDM systems in the presence of a substantial frequency offset is considered. New frequency estimation algorithms for the data aided (DA) mode are presented. The resulting two stage structure is able to cope with frequency offsets in the order of multiples of the spacing between subchannels. Key features of the novel scheme – which are presented in terms of estimation error variances, the required amount of training symbols and the computational load – ensure high speed synchronization with negligible decoder performance degradation at a low implementation effort.

## 1 Introduction

Recently an OFDM system with M-PSK modulation has been suggested as kernel of the system proposal for DAB (digital audio broadcasting) and terrestrial TV [1]. Multi carrier systems, like orthogonal frequency division multiplexing (OFDM), offer several advantages over single carrier transmission schemes in the case of a frequency selective fading channel, i.e. a sophisticated equalization unit mandatory for a single carrier transmission scheme becomes obsolete. However, on the other hand, the frequency synchronization for multi carrier (multi subchannels) systems is more complicated than for single carrier systems. In the case of a carrier offset the orthogonality property is disturbed and the resulting inter-channel interference between the subchannels of the OFDM systems severely degrades the demodulator performance. For high order modulation schemes such as those under consideration for TV applications, a frequency offset of a small fraction of the subchannel symbol rate leads to an intolerable degradation. Therefore, frequency synchronization is one of the most prominent tasks performed by a receiver suitable for OFDM.

Several authors have addressed the frequency synchronization problem for OFDM. Daffara [2] proposed a non data aided (NDA) frequency estimation scheme for an AWGN channel. But such an NDA structure - which does not make use of known symbols - fails in the case of severely frequency selective channels or if a high order modulation scheme is used.

As is well known from single carrier transmission systems in a frequency selective fading channel environment, the frequency synchronization has to be assisted by the transmission of known training sequences [3, 4]. This is also mandatory for multichannel modulation transmission schemes. Müller introduces in [5] a special frame format

where adjacent subchannels carry the elements of a differentially encoded pseudo noise PN sequence and he based his algorithm on a correlation rule applied to this PN sequence. A similar idea is used in our contribution. But in contrast to [5] our algorithm allows the condition on the frame format to be relaxed and we do not have to require – as Müller did – that the channel is quasi constant within a fixed bandwidth. Besides that the synchronization task is performed into two steps, an acquisition step and a tracking step. The paper is organized as follows. We begin by proposing the OFDM receiver and analyzing the effect of a frequency error. Sections 3 – 4 describe the synchronizer structures and the paper ends with the presentation and discussion of the simulation results for the AWGN and various frequency selective fading channels.

## 2 Baseband Model of the Transmission

Figure 1 shows the block diagram of the synchronization path of a receiver for an OFDM modulated signal. We assume that the transmitted complex baseband signal is given by

$$s(t) = \frac{e^{j2\pi f_0 t}}{\sqrt{T_{sym}}} \sum_{l=-\frac{N}{2}+N_G}^{\frac{N}{2}-1-N_G} a_{n,l} e^{2\pi f_l t} g(t - nT_{sym}) \quad (1)$$

where  $N$  is the total number of subchannels and  $N_G = N_{Guard}$  is the number of the subchannels which are not modulated in order to avoid aliasing effects at the receiver [1]. Here,  $g(t)$  is a pulse waveform defined as

$$g(t) = \begin{cases} 1 & -T_G < t \leq T_{sub} \\ 0 & \text{else} \end{cases} \quad (2)$$

where  $T_G$  is the so called guard period. For the sake of a simple transmitter implementation  $T_G$  should be a multiple of  $T_{sub}/N$ . The frequency separation between two subchannels is denoted by  $1/T_{sub}$ . The OFDM symbol duration is given by  $T_{sym} = T_G + T_{sub}$ . In this case  $\{a_{n,l}\}$  is a sequence of M-PSK or M-QAM symbols with  $E\{|a_{n,l}|^2\}$  normalized to one and  $a_{n,l}$  is the symbol carried by the  $l^{\text{th}}$  subchannel during the  $n^{\text{th}}$  time slot of period  $T_{sym}$ . The total symbol rate is given by  $(N - 2N_G)/T_{sub}$ . The variable  $f_0$  stands in (1) for the unknown carrier frequency offset.

The transmitted signal is disturbed by additive white gaussian noise and by a multipath fading channel. In the receiver, the received signal is filtered by a lowpass filter (for example a root raised cosine filter with rolloff factor  $\beta = 0.1$  and a cutoff

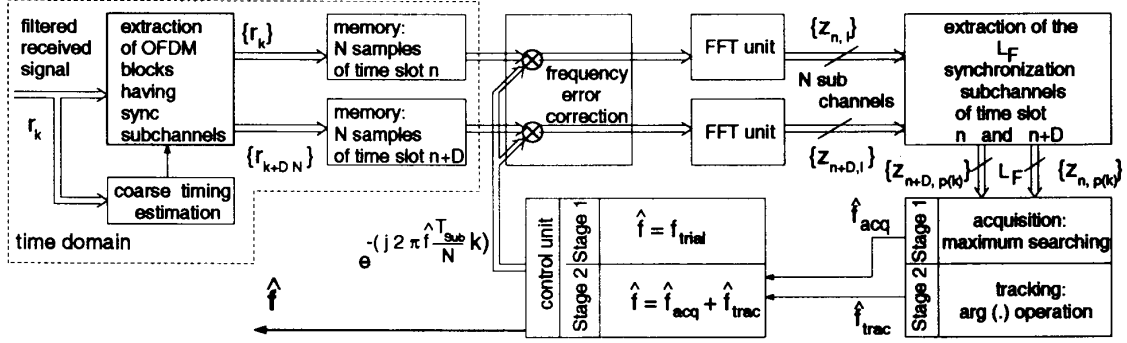

Figure 1: Synchronization path of the receiver

frequency at  $\frac{1}{2N T_{sub}}$ . After deleting the samples which belong to the guardtime period, a block of  $N$  samples is applied to the demodulation unit of the OFDM system. The demodulation unit can be very efficiently implemented by an FFT unit. From the FFT output we obtain the Fourier coefficients of the signal in the observation period  $[n T_{sym}, n T_{sym} + T_{sub}]$ . The FFT unit represents the matched filter of an OFDM modulated signal. The output  $z_{n,l}$  of the  $l$ th carrier at time  $n T_{sym}$  can be written as

$$z_{n,l} = a_{n,l} H(\Omega_l) + n_{n,l} \quad (3)$$

where  $H(\Omega_l) = H\left(\frac{2\pi l}{T_{sub}}\right)$  is the Fourier coefficient of the overall channel impulse response of the transmission channel including the transmitter filter, the channel and the receiver filter. We have assumed that the guardtime is appropriately chosen which means that this time is larger than the significant part of the overall channel impulse response. The complex noise process corrupting the  $l$ th subchannel is represented by  $n_{n,l}$ . The noise process has a statistically independent real and imaginary part each having a variance of  $\frac{N_0}{2} \frac{T_{sym}}{T_{sub}}$ . Therefore  $T_{sym}/T_{sub}$  reflects the fact that the guardtime leads to a theoretical SNR degradation of  $10 \log\left(1 - \frac{T_g}{T_{sym}}\right)$  dB [1]. The samples  $n_{n,l}$  are uncorrelated as long as the noise samples corrupting the  $N$  input samples of the FFT unit are uncorrelated.

Equation (3) is only valid in the case of perfect synchronization. In the presence of an uncompensated frequency offset, the orthogonality of the subchannels can no longer be exploited by the demodulator unit. As a result cross talk between each subchannel arises. The impact of this cross talk can be described by an additional noise component. Within the channel  $l = \nu$  the expected value of the power of this component can be calculated analogously to [2]

$$P_{CT} = P_{CrossTalk} = \sum_{l \neq \nu} s_l^2 (\pi(\nu - l - f_0 T_{sub})) \quad (4)$$

with  $f_0 T_{sub} < \frac{1}{2}$ . Fig. 2 shows the theoretically obtained and

simulated value of  $P_{CT}$ .

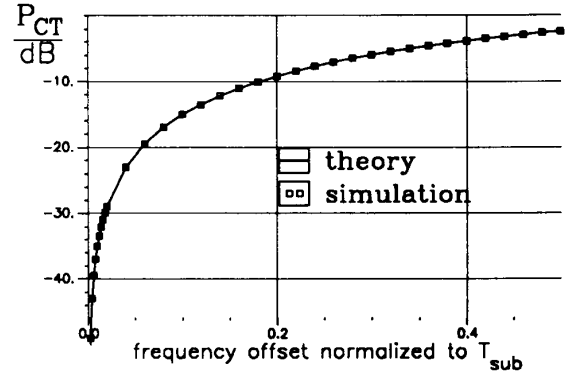

Figure 2: Power  $P_{CT}$  of the cross talk impact,  $E\{|a|} = 1$

For a small frequency offset  $f_0 < \frac{1}{2T_{sub}}$  the output  $z_{n,l}$  can be written as

$$z_{n,l} = e^{j2\pi f_0 n T_{sym}} a_{n,l} \text{sinc}(\pi f_0 T_{sub}) H(f_l) + n_{n,l} + \tilde{n}_{n,l} \quad (5)$$

The exponential term results from the phase drift caused by the frequency offset and  $\tilde{n}_{n,l}$  represents the impact of the cross talk. The phase of this complex valued noise process  $\tilde{n}_{n,l}$  can be shown to be approximately uniformly distributed between  $[-\pi, \pi]$  and the power of this term is given by (4).

### 3 Carrier Frequency Synchronization

Generally we distinguish between two operation modes, the so called tracking mode and the acquisition mode. Whereas during the tracking mode only small frequency fluctuations have to be dealt with, the frequency offset can take on large values (in the range of multiples of the subchannel spacing), if the receiver is in the acquisition mode. This is the most challenging task to be managed by the synchronizer structure.

Below we present a two stage synchronization unit (compare Fig. 1) which provides a robust acquisition behavior and shows an excellent tracking behavior. The task of the first

stage (unit) is to solve the acquisition problem by generating as fast as possible a coarse frequency estimate. With the help of this estimate the second stage (unit) should be able to lock and to perform the tracking task. The splitting of the synchronization task into two steps allows a large amount of freedom in the design of the complete synchronization structure because for each stage an algorithm can be tailored to the specific task to be performed in this particular stage. This means that the first stage – this is the acquisition unit – can be optimized for example with respect to a large acquisition range whereas its tracking performance is of no concern. In contrast, the second stage should be designed to exhibit a high tracking performance since a large acquisition range is no longer required.

In section 3.1 we describe the algorithms for the tracking mode and in section 3.2 we present the algorithms for the acquisition mode. As we will see, a two stage structure does not automatically result in doubled implementation cost, or in the doubling of the required amount of training symbols.

### 3.1 Tracking Algorithm Structure

During the tracking mode it is safe to assume that the remaining frequency offset is substantially smaller than  $\frac{1}{2T_{sub}}$  and therefore (5) holds. If we consider only one subchannel, then this frequency synchronization problem is similar to that in the case of a single carrier problem. Therefore we can make use of the frequency estimation algorithms derived from the ML theory in [6, 7]. The underlying principle of these frequency algorithms is that the frequency estimation problem can be reduced to a phase estimation problem by considering the phase shift between two subsequent subchannel samples e.g.  $z_{n,l}$  and  $z_{n+1,l}$  (without the need of generating an estimate of the channel Fourier coefficient  $H(\Omega_l)$ ). The influence of the modulation is removed in the *data aided* DA case by a multiplication with the conjugate complex value of the transmitted symbols. For the DA case we get

$$\hat{f} 2\pi T_{sym} = \arg \left\{ \sum_{j=0}^{L-1} \left( z_{n+j+1,l}(\hat{f}_{acq}) \right) \right. \\ \left. z_{n+j,l}^*(\hat{f}_{acq}) \left( c_{n+j+1,l}^* c_{n+j,l} \right) \right\} \quad (6)$$

The variable  $(\hat{f}_{acq})$  makes clear that during the tracking period the output of the demodulator unit –  $z_{n,l}(\hat{f}_{acq})$  – depends on the frequency estimate (denoted by  $\hat{f}_{acq}$ ) of the acquisition unit because  $(\hat{f}_{acq})$  is used to correct the input samples of the demodulation unit. The known symbols are represented by  $\{c_{n,l}\}$  and they are taken from a training sequence. To simplify the notation we have denoted the training symbols by the letter “c”.

It is not necessary and, besides that, not commendable to transmit all elements of the training sequence over a single subchannel especially in the case of a frequency selective fading channel. Instead of this the training symbols should be transmitted on e.g.  $L_F$  – so called – sync-subchannels which

should be spread uniformly over the whole frequency domain. The following generalized estimator can be formulated

$$\hat{f} 2\pi T_{sym} = \frac{1}{D} \arg \left\{ \sum_{j=1}^{L_F-1} \left( z_{n+D,p(j)}(\hat{f}_{acq}) \right) \right. \\ \left. z_{n,p(j)}^*(\hat{f}_{acq}) \left( c_{1,j}^* c_{0,j} \right) \right\} \quad (7)$$

The function  $p(j)$  gives the position of the  $j^{\text{th}}$  sync-subchannel, which carries one of the  $L_F$  known training symbol pairs  $(c_{1,j}^*, c_{0,j})$ . Note that  $c_{1,j}^*$  and  $c_{0,j}$  are transmitted over the same subchannel and the symbols  $\{c_{0,j}\}$  belong to the  $n^{\text{th}}$  time period respectively  $\{c_{1,j}\}$  to the  $(n+D)^{\text{th}}$  time period. The overall required amount of training symbols equals  $2L_F$ . Figure 3 shows how the  $L_F$  subchannels should be spread uniformly over the  $N-2N_G$  subchannels.  $D$  is an integer and describes that  $(D-1)$  other symbols can be placed between a training symbol pair [8, 9]. The effect of this operation is explained in section 4.2.

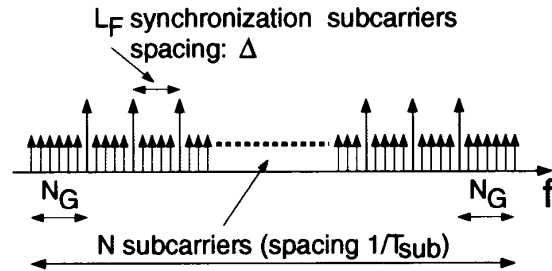

Figure 3: Placement of the  $L_F$  sync-subchannels;  $\Delta = \frac{N-2N_G}{L_F}$

The *data aided* (DA) operation can be replaced by a *decision directed* (DD) operation if the  $(c_{1,j}^*, c_{0,j})$  are substituted by the actual decoder decisions. In the case of an M-PSK modulated symbol a *non data aided operation* (NDA) is possible, too [6]. But we found that from a point of view of a robust tracking performance neither DD nor NDA operation can be recommended especially if a high order modulation scheme is used.

Applying the DA operation it can be shown that the frequency estimator is approximately unbiased for  $|\Delta f T_{sub}| < 0.5$  if  $L_F$  is sufficiently large e.g.  $L_F = 51$  (with  $N = 1024$  and  $N_G = 70$ ). But in order to avoid a large decoder performance degradation due to the cross talk (compare (4)) it may be necessary to correct the frequency offset prior to the demodulation even during the tracking mode (compare Fig. 1). But keep in mind that it is theoretically possible to correct a small frequency offset  $\Delta f T_{sub} \ll 0.5$  on the subchannel level. In practice this will depend on the maximum magnitude of the frequency offset  $(f_0 - \hat{f}_{acq})$  which the second stage (the tracking unit) has to cope with. This magnitude is mainly determined by the frequency estimate resolution of the first stage and the stability of the mixer oscillator.

### 3.2 Acquisition Algorithm Structure

The acquisition process should be performed fast and above all at low implementation cost. Besides this, a special acquisition preamble should be avoided to increase the transmission efficiency. Therefore our aim was to use the same training synchronization symbols as in (7) and to take advantage of those operation units which are implemented in any case. From section 3.1 we know that the second stage can manage frequency offsets up to its pull-in-range of  $|\Delta f T_{sub}| < 0.5$ . Therefore, it is sufficient to require that the acquisition unit reduces the frequency offset below the above mentioned pull-in-range of the tracking unit.

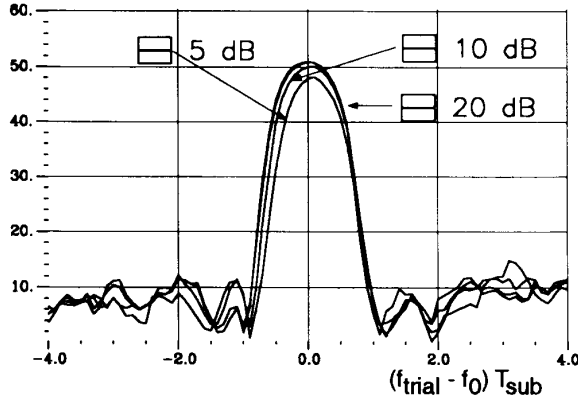

Figure 4: Plot of expression (8),  $L_F = 51$

The operation involved in acquiring an initial frequency offset estimate coincides with the search operation for the training symbols transmitted on the  $L_F$  sync-subchannels shown in Fig. 3. Our acquisition rule is based on the fact that the magnitude of the expression within the  $\arg$  function of (7) reaches its maximum if  $\hat{f}_{acq}$  coincides with  $f_0$ , because this expression obeys a  $\text{sinc}^2(2\pi(f_0 - f_{trial})T_{sym})$  law for  $|f_0 - f_{trial}| T_{sub} < 0.5$  (compare (5)). Therefore we consider the following maximum search procedure

$$\hat{f} 2\pi T_{sub} = \max_{f_{trial}} \left\{ \left| \sum_{j=0}^{L_F-1} \left( z_{n+D,p(j)}(f_{trial}) z_{n,p(j)}^*(f_{trial}) (c_{1,j}^* c_{0,j}) \right) \right| \right\} \quad (8)$$

where  $(f_{trial})$  is the trial frequency and  $z_{n,p(j)}(f_{trial})$  is the output of the FFT unit if its  $N$  input samples are frequency corrected by  $f_{trial}$ . In practice we found that it is sufficient to space the trial parameters  $0.1/T_{sub}$  apart from each other. Figure 4 shows a plot of (8) for different SNR values and  $L_F = 51$  ( $N = 1024$ ) drawn over  $f_0 - f_{trial}$ .

To avoid local maxima occurring for  $f_0 - f_{trial} = (p(j) - p(j-1)) \frac{1}{T_{sub}}$  (with  $j \in \{1, \dots, (L_F - 1)\}$ ), the  $L_F$  products  $(c_{1,j}^* c_{0,j})$  should be elements of a PN sequence. The acquisition performance was found to be independent of the particular shape of the PN sequence (binary- or

CAZAC-sequences). Therefore for the sake of simplifying the implementation the most simple realization of the frame-format results from  $c_{0,j}^*$  being chosen as  $c_{0,j}^* \equiv e^{j \cdot 0}$  and  $c_{1,j}^*$  being taken from an binary PN-sequence as in [10] of length  $L_F$ .

A last comment concerns the implementation complexity and the acquisition time. As shown in Fig. 1 a costly FFT unit is needed within the synchronization path. But this does not mean that an extra FFT unit is required because the FFT of the decoder path, which is implemented in any case, can be used during the acquisition period. Note that the output of the decoder path FFT is not required since during the acquisition process the output is irrelevant. Therefore besides the memory unit (for the  $2N$  samples belonging to time slot  $n$  and  $n + D$ ) no additional expensive hardware is required.

The acquisition time is directly proportional to the frequency range which has to be scanned. In the case of a substantial frequency offset of e.g.  $\pm 10$  subchannel spacings the acquisition time may take on a quite large value. But in practice this does not represent a strong shortcoming, because we are not operating in a burst transmission mode and therefore acquisition has to be performed only once at the beginning of the transmission.

## 4 Synchronizer Performance

### 4.1 Acquisition Performance

Provided there is an unlimited resolution of  $f_{trial}$  the above structure produces an unbiased estimate. Nevertheless, the performance of the acquisition unit should not be measured in terms of an estimate variance or estimation bias alone. A performance measure for a maximum searching algorithm is the probability that an estimation error exceeds a given threshold. In our application this threshold is the pull-in-range of the second stage. We carried out 10.000 independent acquisition cycles and we found that for SNR values above 5dB this threshold was never exceeded for e.g.  $L_F = 51$  (with  $N = 1024$ ,  $N_G = 70$  and  $7.5 \text{ M sym/s}$  as total symbol rate). Summing up, it may be said that the acquisition behavior is uncritical for AWGN channels as well as for frequency selective fading channels.

### 4.2 Tracking Performance

As mentioned above, NDA and DD operation can not be recommended, therefore the theoretical analysis will be restricted to the DA case. Following the method outlined in [6] we obtain for the AWGN channel the general expression

$$\text{Var}\{\hat{\Omega} T_{sym}\} = \frac{1}{L_F} \frac{1}{D^2} \frac{E\{|a|^2\}}{E\{|c|^2\}} \left( \frac{1}{SNR} + \frac{2 E\{|a|^2\}}{E\{|c|^2\}} \frac{1}{(2SNR)^2} \right) \quad (9)$$

Fig. 5 shows the simulated and analytically obtained variances. The curves are parametrized by the number of sync-subchannels  $L_F$  (therefore, the overall required number of training symbols is  $2L_F$ ). As indicated in (9) in practice it

may be advantageous to select  $E\{|c|\} \neq E\{|a|\}$ . Additionally, Fig. 5 makes the effect of factor  $D$  clear. But to avoid any misunderstanding, the improvement of the performance by selecting  $D > 1$  is only possible if the channel can be considered as quasi static within a time period  $T_{sym}(D + 1)$ .

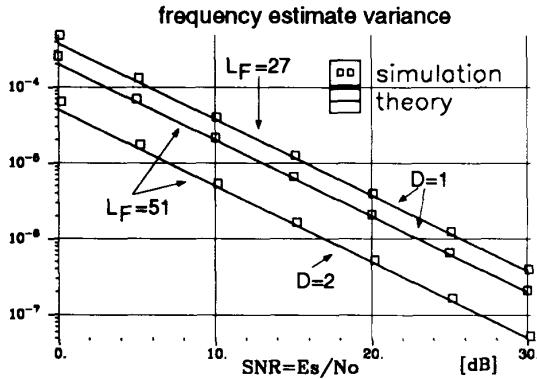

Figure 5:  $\text{Var}\{\hat{\Omega}T_{sym}/2\pi\}$ , AWGN channel,  $E\{|c|\} = 1.41$ , 64QAM modulation and  $E\{|a|\} = 1$ ,  $SNR = E_s/N_0$

If the channel varies significantly within  $T_{sym}$  the orthogonality of the subchannels can no longer be exploited and as a result  $z_{n,l}$  is disturbed by cross talk effects. These effects are proportional e.g. to the amount of the (time selectivity) Doppler delay spread. Figure 7 shows the simulation results for a frequency and time selective fading channel (with  $N = 1024$ ,  $N_G = 70$  and  $7.5 M_{sym}/s$  as total symbol rate) whose multipath delay profile is sketched in Fig. 6. The strong performance degradation in the case of a Doppler

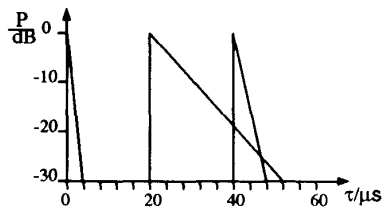

Figure 6: Multipath delay profile

spread of  $\lambda = 88 \text{ Hz}$  results from the impact of the time selectivity. This impact becomes dominating for high SNR values. But since the expected value remains unbiased a further improvement of the estimate can be obtained via a filtering of the estimates.

## 5 Discussion and Conclusion

The performance of a two stage synchronization structure has been studied. The synchronization structure is able to cope with large frequency offsets in the range of multiples of the spacing between the subchannels. Analysis and simulations have shown that fast and robust synchronization can be established at low implementation cost on AWGN as well as

on frequency selective fading channels. A final comment concerns the timing information. Up to now timing is assumed to be known. Investigations not reported here have shown that a slight modification of the preamble allows the above frequency synchronization structure to be efficiently combined with a timing synchronization structure.

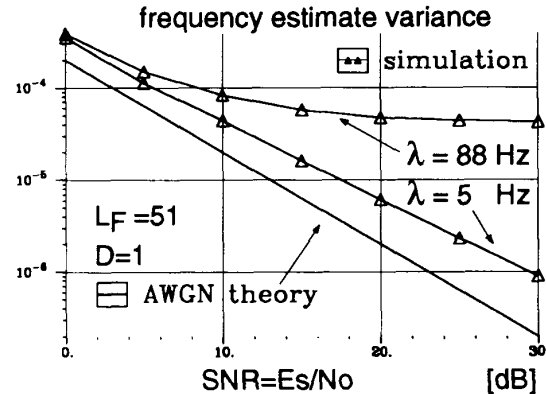

Figure 7: Influence of the time selectivity on  $\text{Var}\{\hat{\Omega}T_{sym}\}$ ,  $E\{|c|\} = 1.41$ , 64QAM modulation and  $E\{|a|\} = 1$ , channel of Fig. 6

## Bibliography

- [1] Paul G.M. de Bot, Stan Baggen, Antoine Chouly and Americo Brajal. An Example of a Multi-Resolution Digital TV Modem. *Proceedings ICC'93*, pages 1785-1790, 1993.
- [2] Flavio Daffara and Antoine Chouly. Maximum Likelihood Frequency Detectors for Orthogonal Multicarrier Systems. *Proceedings ICC'93*, pages 766-771, 1993.
- [3] Chevillat, P.R., Maiwald, D., and Ungerboeck, G. Rapid Training of a voiceband Data Modem Receiver employing an Equalizer with fractional T-spaced Coefficients. *IEEE Trans. Commun.*, COM-35:869-876, Sep. 1987.
- [4] Fechtel, S.A. and Meyr, H. Fast-Frame Synchronization, Frequency Offset Estimation And Channel Acquisition For Spontaneous Transmission Over Unknown Frequency Selective Radio Channels. In *Proceedings PIMRC'93 Yokohama, Japan*, Sep. 1993.
- [5] Andreas Müller. Schätzung der Frequenzabweichung von OFDM-Signalen. *ITG Fachbericht Nr. 124 Mobile Kommunikation, Neu-Ulm*, pages 89-101, Sept. 1993.
- [6] Ferdinand Classen, Heinrich Meyr and Philipp Sehier. "Maximum Likelihood Open Loop Carrier Synchronizer for Digital Radio". *Proceedings ICC'93*, pages 493-497, 1993.
- [7] Steven Kay. A fast and accurate single frequency estimator. *IEEE Trans. Acoust., Speech, Signal Processing*, ASSP-37(12):1987-1990, December 1989.
- [8] Ferdinand Classen, Heinrich Meyr and Philipp Sehier. "An All Feedforward Synchronization Unit for Digital Radio". *Proceedings VTC'93*, pages 738-741, 1993.
- [9] Jack Wolf and Jay Schwartz. Comparison of Estimators for Frequency Offset. *IEEE COM*, (1):124-127, Januar 1990.
- [10] J. Lindner. "Binary Sequences up to Length 40 with Best Possible Autocorrelation Function". *Electronics Letter*, Vol 11:507, 1975.